



Make sure you have everything before you start soldering!

CAPACITORS

- 0.1µF Ceramic x1

 C1
- 10µF Electrolytic x1

 C2

DIODES

- 1N4148 x1

 D35

ICs

- PIC16F1783 x1

 U1

JACKS

- 3.5mm Switched x4

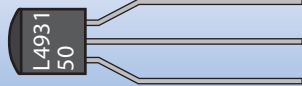
 J1, J2, J3, J4

VOLTAGE REGULATORS

- L4931CZ50 (5V) x1

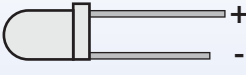
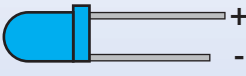
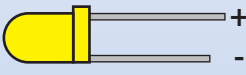
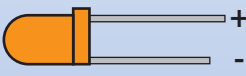
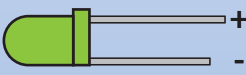
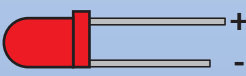
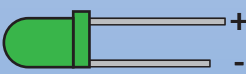
 VR1

LEDs

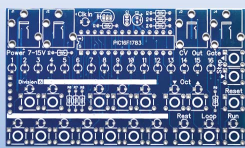

- 3mm - White x1

 D1
- 3mm - Blue x16

 D2-D17
- 3mm - Yellow x12

 D18-22, 25-31
- 3mm - Orange x1

 D23
- 3mm - Green x1

 D24
- 3mm - Red x2

 D32-D33
- 3mm - True Green x1

 D34

PCBs / PANELS

- Sequencer PCB x1

 PCB1

 Assembly instructions can be found at division-6.com/card

RESISTORS

- 1K x2

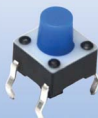
 R2, R3
- 100Ω x5

 R4, R6, R7, R8, R9
- 100K x1

 R5

BUTTONS / SWITCHES

- Tact Switch - 6mm x20

 S1-S20